

LIGHTSOFT



Indirect light-emitting bollard range with integrated solar panels. Smooth and sharp devised bollard family with digital controller and integrated battery enabling both mains and solar power supply.



Luminaire Structure

- Die-cast aluminium housing
- Extruded aluminium column
- Pre-treated before powder coating ensuring high corrosion resistance
- Stainless steel fasteners in grade 304 with zinc flake coating (ZFC)
- Durable silicone rubber gasket
- High-efficiency optical reflector or PMMA lens
- Clear UV-stabilised polycarbonate diffuser
- Anodised, high-purity aluminium reflector
- Integral control gear
- Solar panel mono-crystalline silicon high-efficiency 4x10W
- Lithium Iron Phosphate (LiFePO4) battery 16.5Ah 12 VDC
- Solar charger controller system 12V 10A

- Luminaires operation time depends on the weather conditions
- Full automatic electronic protection function against short circuit, overcurrent, overload, overvoltage and high temperature
- Standard: Off-grid, 100% solar, not connected to the utility grid. Utility grid connection is available upon request
- Without any sun (Autonomy), the battery would last for a maximum 5 days
- Motion sensor integrated
- Different dimming options are available
- STD: 2 Step dimming with motion sensor override (3 hours: 60% without movement, 100% for 1 minute when the motion sensor activated. After 3 hours: 30% without movement, 60% for 1 minute when the motion sensor activated)

- ND: Dusk to Dawn, CT: Custom examples are 5 Step dimming, Custom hours, Custom dimming levels (Step length and minimum dim level is 10%)
- Maximum 35.5 hours of operation time (2 Step dimming with motion sensor override)
- Remote solar charge controller can be ordered as an accessory
- Autonomy and Operation time calculations are done with the following information: Peak Sun-Hour (PSH) is 3 hours. Hours of operation are 12 hours per day. Detection of movement is 5 times per hour.
- Autonomy and Operation time calculations are only indicative and will depend on several variable factors. Please contact the factory to determine the specific calculations for your project.

Feature



Optic



W VW T2 T3

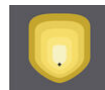

T4

Product colour



01 - Black (RAL 9011) 02 - Dark Grey (RAL 7043) 03 - White (RAL 9003) 05 - Matt Silver (RAL 9006)



06 - Bronze (RAL 6014)

Special finishes upon request

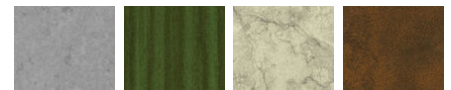

SU01 - Concrete - Urban SU02 - Softscape - Urban SU03 - Stone - Urban SU04 - Corten - Urban

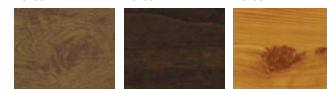

SW01 - Oak - Woodland SW02 - Walnut - Woodland SW03 - Pine - Woodland

We reserve the right to make technical and design changes.

01:13, 28-06-2024

<https://www.ligman.com/lightsoft-solar-integrated-bollards-light-s-bo3/>

THAILAND



LIGMAN Lighting Co.,Ltd.
17/2 Moo 4, Monthong, Bang Nam Priao,
24150 Chachoengsao - Thailand
info@ligman.com

LIGHTSOFT

Technical information

Model number	Light source	Power	Lumen	Optic	CCT / CRI	Dimming type	Weight	
186x186 mm - 1000 mm - 10.5 hours of operation time (2 Step dimming with motion sensor override) - 5 days of autonomy								
LIGHTSOFT 20	LH-10823	18 LED	6 W	528 lm	W [108°], VW [120°], T2 [136°x22°], T3 [140°x44°], T4 [148°x78°]	3000K CRI80, 4000K CRI80	Dusk to Dawn, 2 Step dimming with motion sensor override, Solar Custom	19 kg
186x186 mm - 1000 mm - 17.5 hours of operation time (2 Step dimming with motion sensor override) - 5 days of autonomy								
LIGHTSOFT 20	LH-10822	18 LED	4 W	352 lm	W [108°], VW [120°], T2 [136°x22°], T3 [140°x44°], T4 [148°x78°]	3000K CRI80, 4000K CRI80	Dusk to Dawn, 2 Step dimming with motion sensor override, Solar Custom	19 kg
186x186 mm - 1000 mm - 35.5 hours of operation time (2 Step dimming with motion sensor override) - 5.5 days of autonomy								
LIGHTSOFT 20	LH-10821	18 LED	2 W	176 lm	W [108°], VW [120°], T2 [136°x22°], T3 [140°x44°], T4 [148°x78°]	3000K CRI80, 4000K CRI80	Dusk to Dawn, 2 Step dimming with motion sensor override, Solar Custom	19 kg

Accessories

 Anchor bolt A10391	 Remote solar charge controller for Solar Integrated Bollards and Vertical Solar PV poles A92691	LH-10821	•	•
		LH-10822	•	•
LH-10823	•	•		

LIGHTSOFT

Adjustable sensor (10 - 150 seconds)
 360° sensitivity
 Sensor detection area: 7 - 10 m

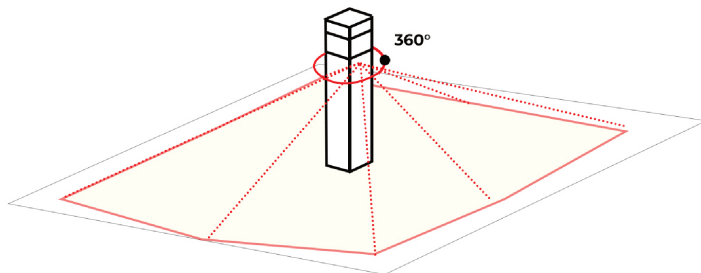

LH-10821, LH-10822, LH-10823

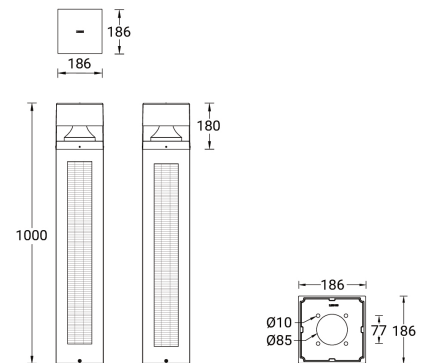

LIGHTSOFT

LIGHTSOFT
Surface facade luminaires

Surface wall-mounted wall decorative family. Hidden-source, perfectly glare free contemporary ambient lighting fixtures.

<https://www.ligman.com/lightsoft-surface-facade-luminaires-lig-su3/>

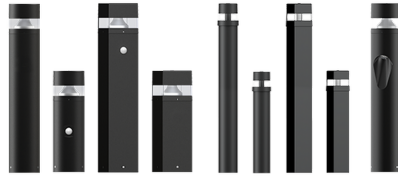

LIGHTSOFT
Bollards

Indirect light-emitting bollard range. Smooth and sharp devised bollard family with wonderful soft controlled lighting options.

<https://www.ligman.com/lightsoft-bollards-lights-bo3/>